

Model Number: RG10L5(2HS)/BGEFU1, RG10L4(2HS)/BGEFU1,  
RG10R(2S)/BGEFU1, RG10L4(2S)/BGEFU1, RG10F8(2)/BGEFU1

Location: \_\_\_\_\_

Approval: \_\_\_\_\_

Engineer: \_\_\_\_\_

Date: \_\_\_\_\_

Submitted to: \_\_\_\_\_

Construction: \_\_\_\_\_

Submitted by: \_\_\_\_\_

Unit #: \_\_\_\_\_

Reference: \_\_\_\_\_

Drawing #: \_\_\_\_\_



SPECS		
Power supply	V	3.0V( Dry batteries R03/LR03×2)
Product Size (HxWxD)	inch	2 x 7/8 x 7-5/8
	mm	49 x 22 x 193
Signal Receiving Range	ft	26.2
	m	8
Operating Temperature Range	°F	23~140
	°C	-5~60

### Dimension

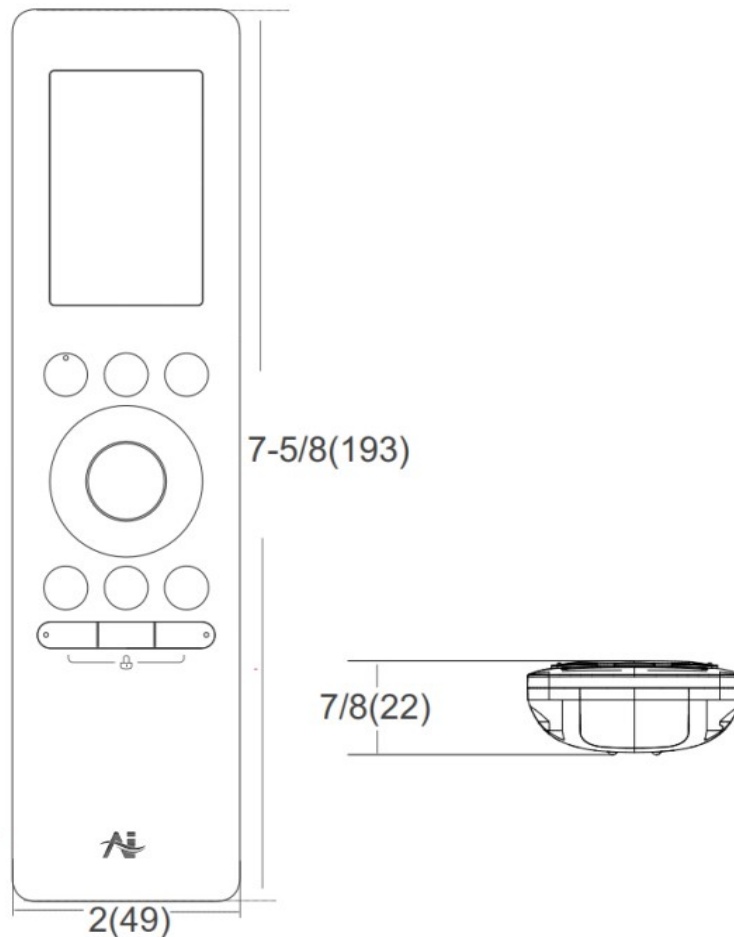

## Display

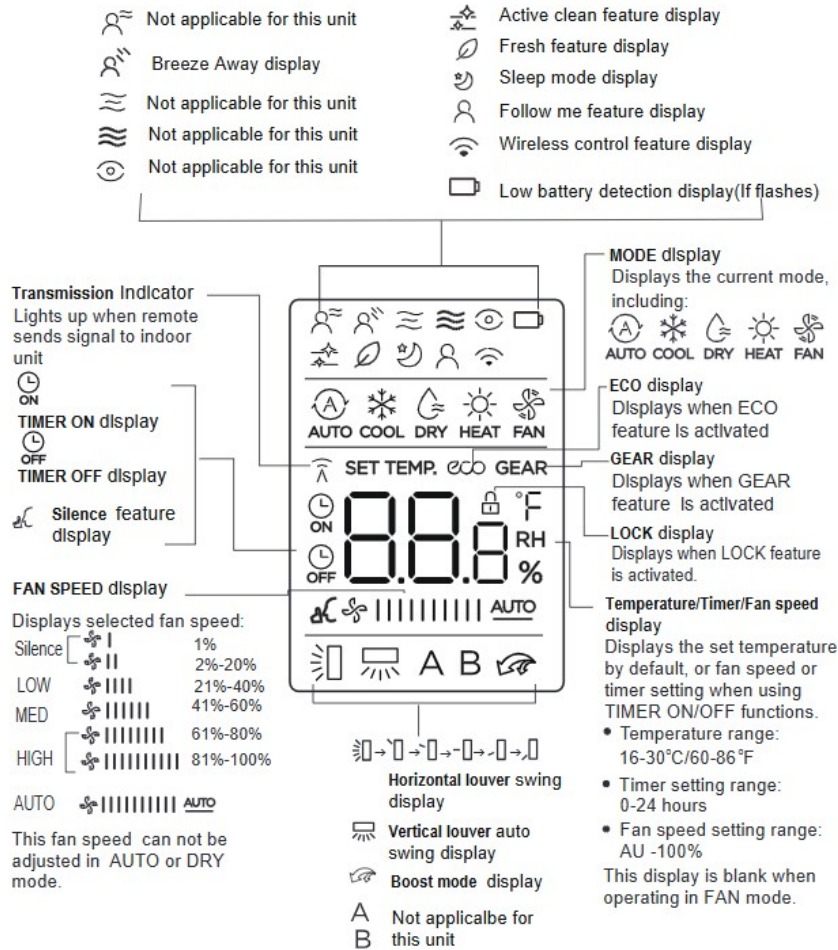

## Button and function

### RG10L5(2HS)/BGEFU1

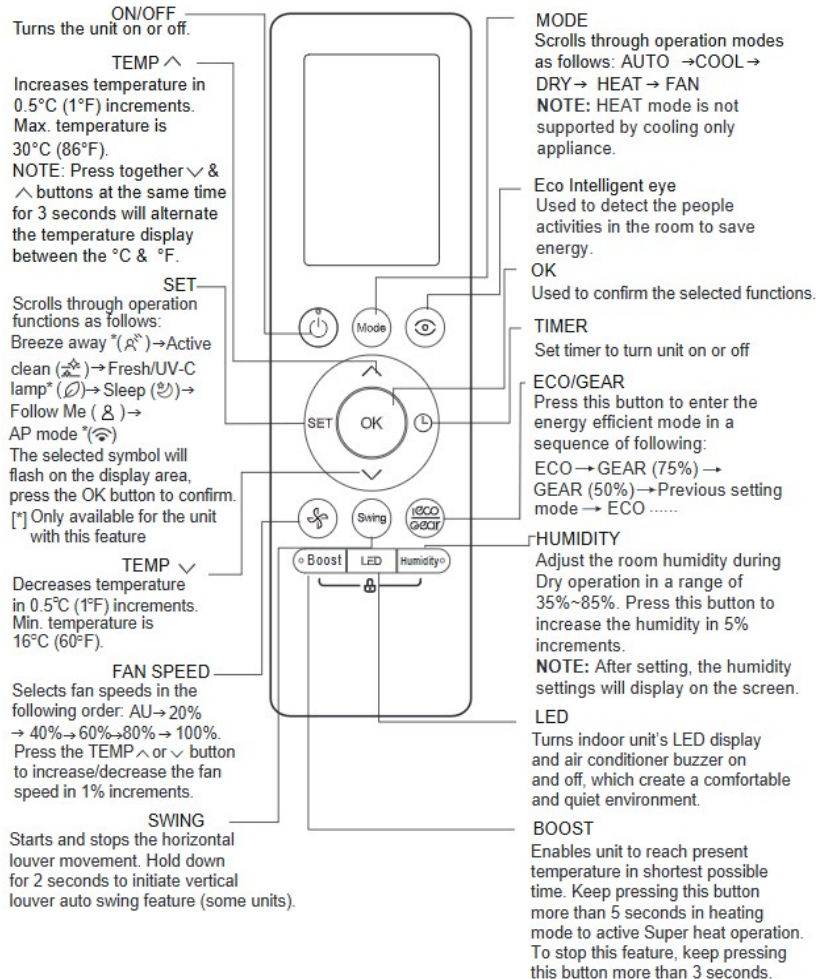

## RG10L4(2HS)/BGEFU1

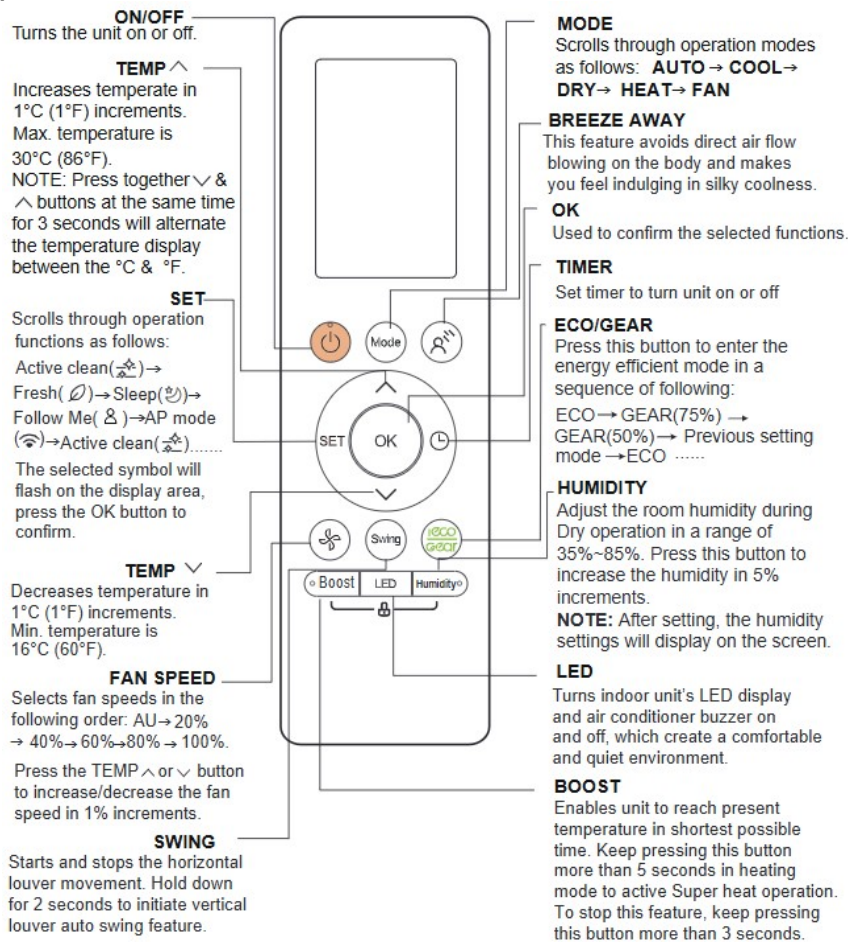

## RG10R(2S)/BGEFU1

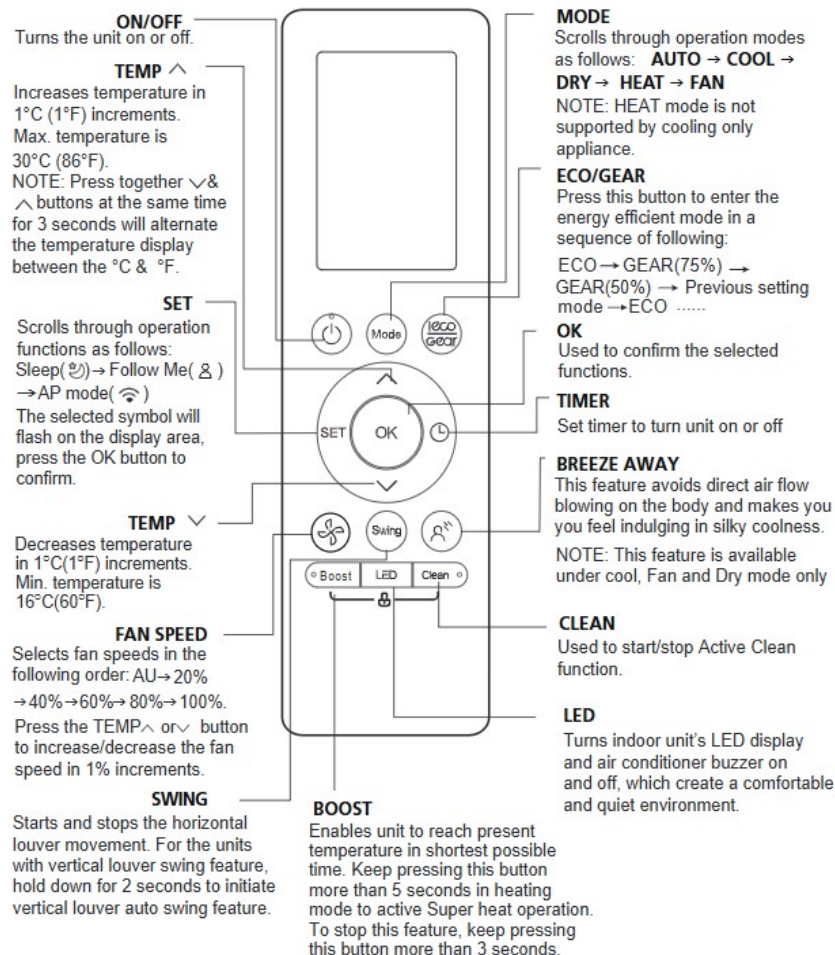

## RG10L4(2S)/BGEFU1

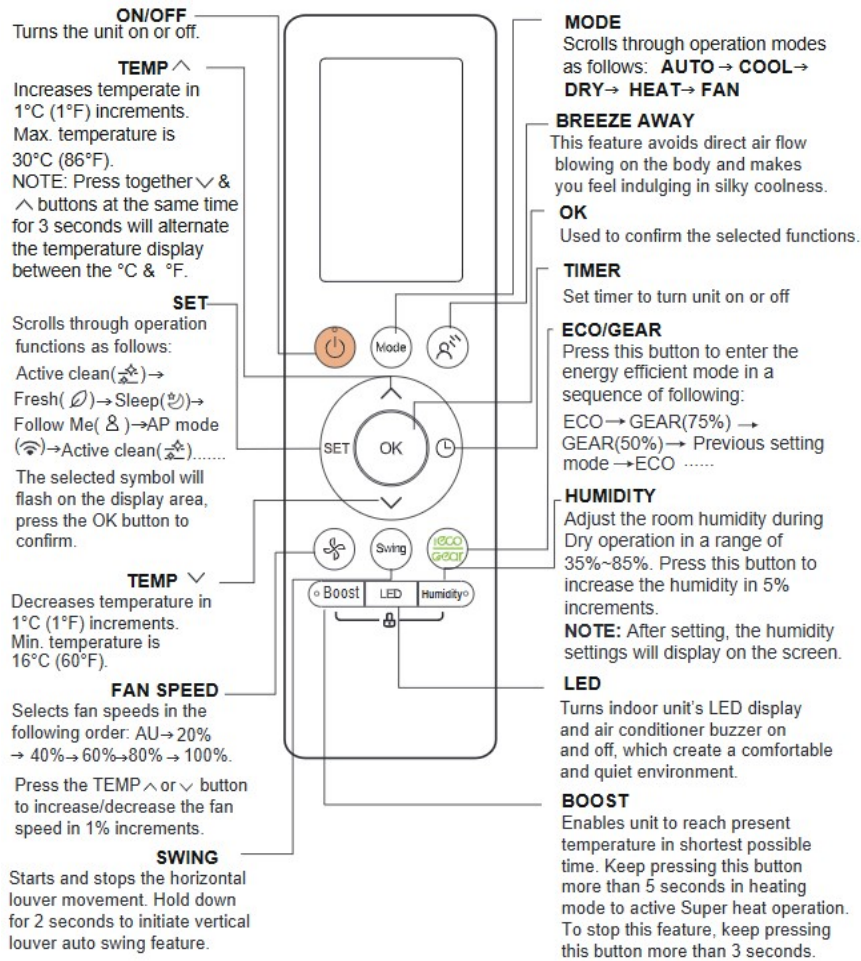

## RG10F8(2)/BGEFU1

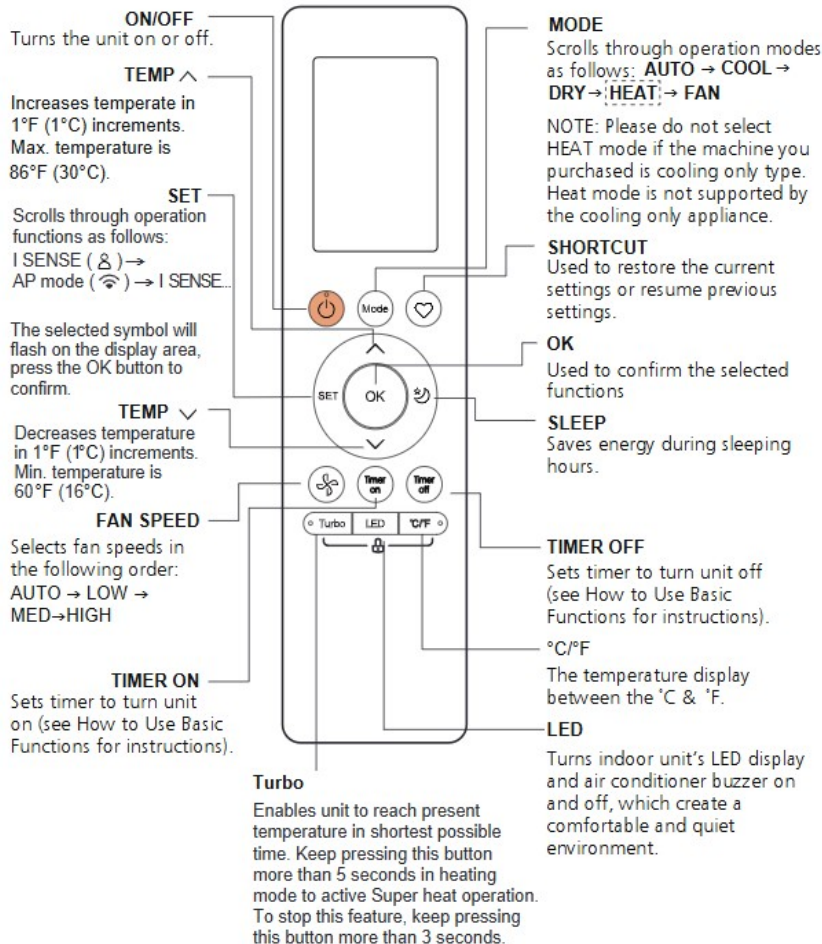

# Compatibility Chart

	Model Number	R454B Series												
		EP	AG	AF	Console	1-way cassette	4-way cassette	Ceiling&Floor	Slim duct	2nd Gen. AHU	3rd Gen. AHU	Wall Mounted AHU	Pancake	A-Coil
Remote Controller	RG10R(2S)	No	Yes	Yes	No	No	No	No	Yes	No	No	No	No	No
	RG10L5(2HS)	Yes	No	No	Yes	No	Yes	No	No	No	No	No	No	No
	RG10L4(2HS)	No	No	No	No	Yes	No	No	No	No	No	No	No	No
	RG10L4(2S)	No	No	No	No	No	No	Yes	No	No	No	No	No	No
	RG10F8(2)	No	No	No	No	No	No	No	No	Yes	Yes	Yes	Yes	No