

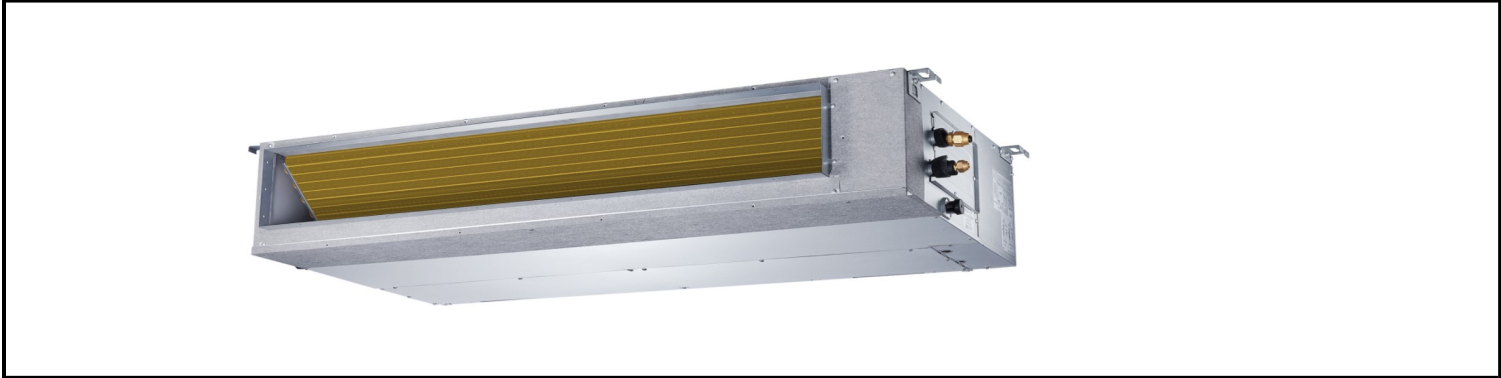

Model Number: AL-06N2-M1

Location: _____
 Engineer: _____
 Submitted to: _____
 Submitted by: _____
 Reference: _____

Approval: _____
 Date: _____
 Construction: _____
 Unit #: _____
 Drawing #: _____



Item	Unit	Specification
Performance Data		
Cooling Capacity	Btu/h	6500(3300~11800)
Heating Capacity	Btu/h	8000(3700~13100)
Design Pressure	PSIG	550/340
Refrigerant Type	-	R454B
Liquid Side	inch(mm)	1/4in (6.35mm)
Gas Side	inch(mm)	3/8in (9.52mm)
Indoor Operation Range of Cooling	Deg.°F (°C)	60°F~90°F (16°C~32°C)
Indoor Operation Range of Heating	Deg.°F (°C)	32°F~86°F (0°C~30°C)
Electrical		
Normal Operational Voltage	V, Hz, Ph	208/230V,60Hz,1Ph
Voltage Range	V	187-253
Connection Wiring	-	AWG 14-4
Indoor Fan Motor Model	-	ZKFN-81-8-1
Indoor Fan Motor Output	W	81
Indoor Fan Motor RLA	A	1.2
Indoor Fan Motor Speed(Hi/Mi/Lo)	r/min	980/910/840
Air Flow & Noise Level		
Indoor Air Flow (Turbo/Hi/Mi/Lo/Si)	CFM	324/265/206/147/118
Indoor Noise Level (Turbo/Hi/Mi/Lo/Si)	dB(A)	33/33/31/30/22
Moisture Removal	L/H (pint/H)	N/A
Dimension (W×D×H)	inch	27-1/2 x 19-7/8 x 7-7/8
	mm	700 x 506 x 200
Package (W×D×H)	inch	33-7/8 x 21-1/4 x 11-1/4
	mm	860 x 540 x 285
Net Weight / Gross Weight	lbs	39/47
	kg	17.9/21.2

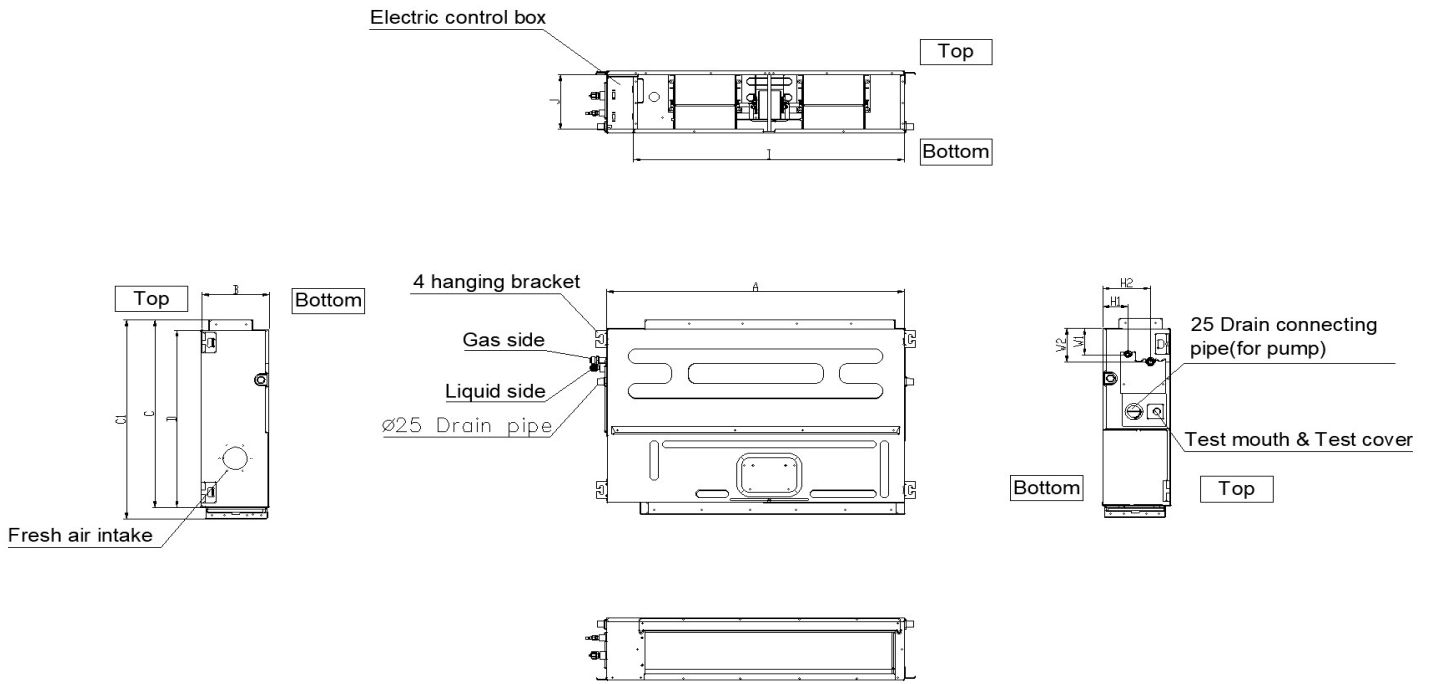

Model(kBtu/h)	unit	A	B	C	C1	D
	6 -12	mm	700	200	470	506
in		27-1/2	7-7/8	18-1/2	20	17-3/4
18	mm	880	210	634	674	600
	in	34-5/8	8-1/4	25	26-1/2	23-5/8

Installation Instruction

Installation place

The distance between the mounted indoor unit should meet the specifications illustrated in the following diagram.

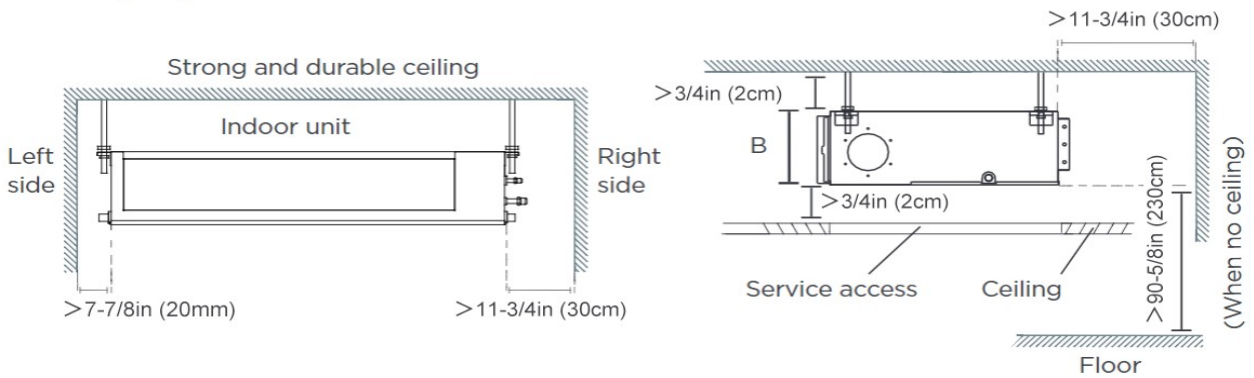

FEATURES

- Static pressure with 4 levels to select
- Refrigerant leakage detector
- Constant airflow
- Built-in water pump
- i-clean function (AI self cleaning)
- 1~100% stepless adjustable fan speed setting
- WiFi capability: through WiFi module or wired controller with WiFi function
- OTA function: can upgrade the program version via wired controller 120N(X6W)
- 2-pin connector(HA/HB) for programmable wired controller
- Multiple controller options available:
 - Optional two way communication wired controller, programmable:120N(X6)
 - Optional two way communication wired controller, programmable, with built-in WiFi, :120N(X6W)
 - Optional Infrared wired controller: 120L
 - Optional Wireless remote controller
 - Optional 24V interface kit, can connect with Third-Party 24V Thermostat